

Facing and Boring Heads

UPA



WOHLHAUPTER

Für Ihren Erfolg.

Universal Facing and Boring Heads

For use on universal milling and boring machines, jig borers etc.
suitable for all types of work in single or series production.

Product range UPA 3 to UPA 5-S 6

UPA 3, 4 and UPA 5-S6 are only delivered with screw-on tool shanks (DS)

UPA 3

- Working range: \varnothing 0 – 260 mm
- Slide adjustment: 48 mm
- Almost every type of shank, for tapers from ISO 30 and from MT 3, can be fitted to the UPA head



UPA 4

- Working range: \varnothing 0 – 400 mm
- Slide adjustment: 52 mm
- Almost every type of shank, for tapers from ISO 40 and from MT 4, can be fitted to the UPA head



UPA 5-S 6

- Working range: \varnothing 0 – 620 mm
- Slide adjustment: 112 mm
- Almost every type of shank, for tapers from ISO 40 and from MT 5, can be fitted to the UPA head



Technical data

Type and size	UPA 3	UPA 4	UPA 5-S 6					
	with rapid return in the same direction of revs.	Rapid return setting by quickset spindle The S-types have a lengthened slide						
Working accuracy, mm	± 0.005	± 0.005	± 0.005					
Types of possible shanks:								
mm Ø	25	35	45					
MT	3	4	5					
ISO	30	40	40					
Metric	-	-	-					
Facing and boring range, mm in Ø	0 – 260	0 – 400	0 – 620					
Adjustment of slide, max. mm	48	52	112					
Self activated feed of slide per rev. in mm	0.0507	0.02 0.04 0.06 0.08 0.10 0.12 0.14 0.16 0.18 0.20 0.22 0.24						
Fine adjustment:								
1 division mm in Ø	0.01	0.01	0.01					
1 revolution mm in Ø	1.0	0.4	0.4					
Rapid return per revolution, mm in Ø	1.0	-	-					
Rapid return setting per revolution, mm in Ø	-	6.0	6.0					
Largest dia. of slide, mm	85	115	170					
Height of head without shank, mm	75	128	128					
Tool locations in slide, mm Ø	18	22	22					
Weight of head (without shank), kg	2.1	6.5	7.9					
Max. permissible revolutions	1000	600	600					
End cut off accuracy	± 0.05	± 0.05	± 0.05					

Chip production values

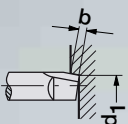
Guide for chip cutting			UPA 3	Type and size					
			UPA 4	UPA 4			UPA 5-S 6		
	Max. load	KW	2.5	7.0			9.5		
	With slide feed	mm/rev.	0.050	0.08	0.12	0.24	0.08	0.12	0.24
	For smaller working Ø	d ₁ , mm	60	150			200		
	Max. width of chip	b, mm	4	7	6	4	8	7	5
	Max. working Ø	d ₁ , mm	260	400			500 / 620		
Max. width of chip	Without reinforcement rings	b, mm	2	2.2	2	1.5	2.5	2	1.5
	With reinforcement rings ¹⁾	b, mm	-	4.5	4	3	5	4	3

¹⁾ By using the reinforcement rings, contained in the normal attachment, chip cutting capacity is increased by 100%.

Operation

UPA 3

Facing:

For facing, the feed of the slide is engaged with the feed button and the holding ring is stepped with the holding bar. This controls – while machine spindle is revolving – the facing feed. Slide travel can be preset with stops. When the stop reaches the fixed pin, the facing feed stops automatically. When the rapid return button is pressed, – which can also be done while the machine spindle is rotating, the slide returns to the starting position. This button can also be used for stopping the facing feed at any time.

Boring:

The setting in general and the feed for cylindrical internal and external boring is done by scale ring. After feed-in the slide is clamped by the clamping screw.

Taper Turning:

For this operation, the feed of head and machine feed must be at the correct ratio.

- 1 Stop
- 2 Fixed pin
- 3 Feed button
- 4 Scale ring
- 5 Holding ring
- 6 Return button
- 7 Holding bar
- 8 Adjusting screw
- 9 Slide with bores for tool location



UPA 4 / 5-S 6

Facing:

For facing, press drive pin and stop holding ring with the holding bar. 12 different facing feed steps can be set by feed button (from 0.02 – 0.24 mm/rev.). One sets facing feed while machine spindle is revolving. The feed can be set with the stop. When the stop reaches the fixed pin, the facing feed stops automatically. The return setting or the rough feed of the slide is set by the quick setting spindle with the operating key.

Boring:

The slide setting for cylindrical turning (internal and external) is achieved by either using the quick setting spindle or the fine setting spindle. After bringing the slide forward, it is clamped with the clamping screw.

Taper Turning:

For taper turning and when cutting conical threads, the feed of the head and machine feed must be at the correct ratio.

Thread Cutting:

When thread cutting on machines with suitable axial feed, the cutting tool is adjusted with the fine setting spindle and lifted with the quick setting spindle.

- 1 Stop
- 2 Fixed pin
- 3 Fine setting spindle
- 4 Feed buttons
- 5 Release ring
- 6 Feed ring
- 7 Adjusting screw
- 8 Ring
- 9 Drive pin
- 10 Holding bar
- 11 Quick setting spindle
- 12 Slide with tool location bores

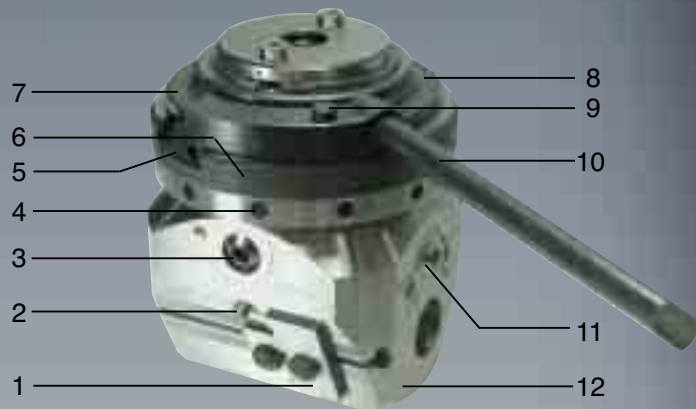

Storage boxes for Facing and Boring Heads and Attachments

Boxes to fit the following types of shank:

- UPA 3 with screw-on shank
MT 3, MT 4, ISO 30 or ISO 40
- UPA 4 and with screw-on shank
UPA 5-S 6 to MT 5, ISO 40, ISO 50



Tool location

The boring heads UPA 3 up to UPA 5 – S6 are only supplied with DS-connection (detachable shanks). These can be used without reservation, for right or left turning. The mounting is done by a differential thread pin and no important parts need removing.

There are two cylindrical pins for the turning moment drive. For the mounting of the tool shank to the facing and boring head the following must be observed: When mounting, turn the operational key to the left, when releasing, turn key to the right.



Applications

WOHLHAUPTER Facing and Boring Heads

The universal tool for working in single parts or work in series.



Boring with several different bits
from \varnothing 0.5 – 1250 mm

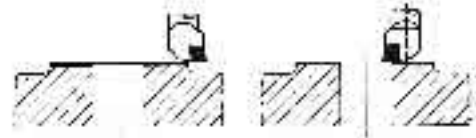

Facing
From inside outward
From outside inward

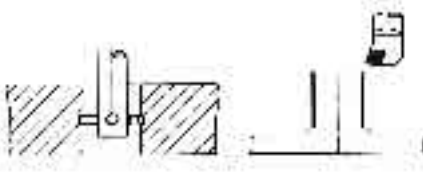

Recessing

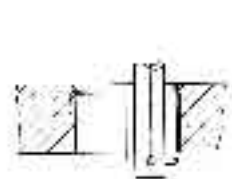

Outside \varnothing
turning

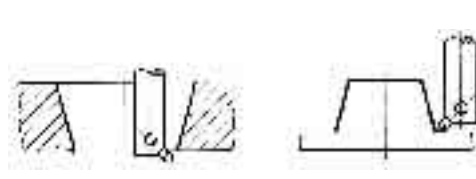

Thread cutting

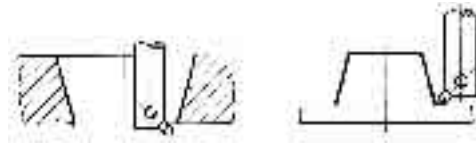

Taper turning

Examples – Application of the attachments –



Facing with bit fixed
directly in slide

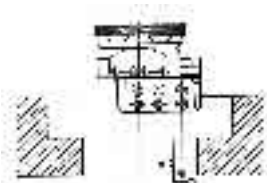

Boring with long
boring bar



Boring and facing with short
boring bar holder and a boring
bar

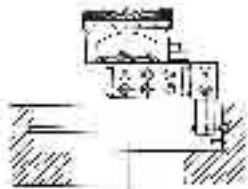

Recessing with short boring
bar holder and a boring bar



Because of the small construction of
the facing and boring heads deep
bores can be made. In this case the
boring bit is fixed directly in the slide.

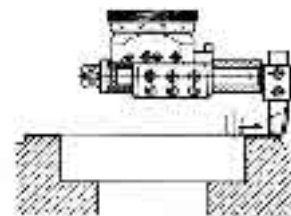

Facing of large \varnothing with long
boring bar holder reinforced by
rings and draw in screw.

Für Ihren Erfolg.



Facing in two areas with one boring bar and a boring bar holder

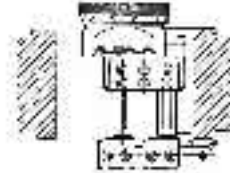

Facing of the reverse side by using boring bar holders contained in attachment

Application Examples – with special tool holder –

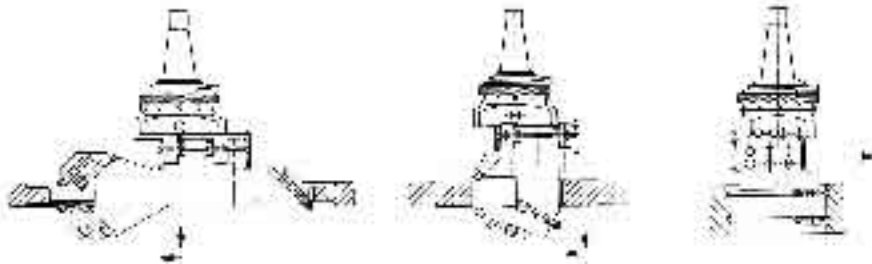

Multiple use for production in series:
Facing, boring, recessing and chamfering by using special tool holder, fixed in the facing and boring head.

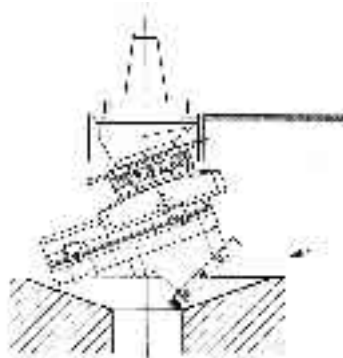

For work on slanted areas with a conical angle of $120^\circ - 180^\circ$, the usual type of UPA head can be provided with a slanting flange. For single application a special tool holder is mounted on the slide.

Facing and Boring Head UPA 3

The universal tool for facing, boring, recessing, thread cutting and for special work, for use on universal milling machines, jig borers, boring machines etc.

Working range: Ø 0 – 260 mm

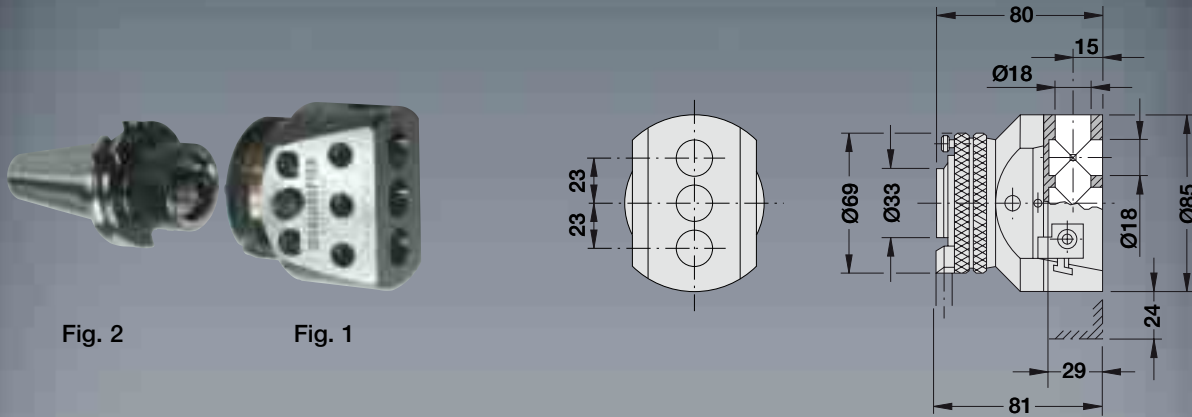

	Weight, kg	Order Number
Facing and boring head UPA 3 (as fig. 1)	2,1	005 020

The facing and boring head (fig. 1) is arranged for mounting DS-tool shanks (fig. 2). Because shanks can be exchanged, this facing and boring head can be used on machines with different spindle locations. With each tool shank a differential thread pin and an operation key is supplied. When mounting, the instructions on mounting sheet No. 102 200 should be followed.

DS-tool shanks, fig. 2		Weight, kg	Order Number	No. of drawings	
MT 3 x Tang (M 12 unscrewable)	DIN 1806	0.4	130 001 T00 4509	K 9674	
MT 3 x Tang (1/2 in. – 12 BSW unscrewable)	DIN 1806	0.4	130 001 T00 4509	K 10005	
MT 4 x Tang	DIN 1806	0.6	130 001 T00 3590	K 9462	
MT 4 x M 16	DIN 2207	0.7	130 001 T00 4256	K 9461	
MT 4 x M 14	SIP	1.0	130 001 T00 4255	K 9843	
MT 5 x Tang	(OERLIKON)	DIN 1806	1.4	130 001 T00 3920	K 9358
Collet location R8	BRIDGEPORT	0.5	130 001 T00 7166	K 9532	
Special taper Ø 28,575 mm	MOORE	0.4	130 002 T00 4474	K 9874	
ISO 30 x M 12	DIN 2080	0.4	130 001 T00 3673	K 9466	
ISO 40 x M 16	DIN 69871	1.0	130 001 T01 3815	K 14150	
ISO 40 x M 16 cap screw clamping	DIN 2080	1.0	130 001 T00 3703	K 9469	
ISO 40 x 5/8 in. – 11 BSW	similar	DIN 2080	0.9	130 001 T00 4498	K 9906
ISO 50 x M 24	DIN 2080	2.8	130 001 T00 3704	K 9470	
ISO 50 x 1 in. – 8 BSW	similar	DIN 2080	2.7	130 001 T00 4480	K 9912
Norm taper 40 x S 20 x 2 with bolts DECKEL		1.0	130 001 T00 5070	K 8620	
ISO 40 x M 16 (chucking groove)	DIN 2080*	0.8	130 001 T01 0229	K 10246	
ISO 50 x M 24 (chucking groove)	DIN 2080*	2.8	130 001 T01 0048	K 10069	

* with chucking groove

Other types of shanks on demand

Accessories

Boring bars

Boring depth, mm	Designation	l_1 , mm	Order No.
30	B 306	60	073 003
60	B 309	90	073 004
90	B 312	120	073 005

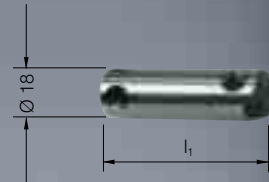

Boring bar holders

Working \varnothing , mm	Designation	l_1 , mm	Order No.
85 – 190	BH 308	82	075 001
160 – 260	BH 312	120	075 002

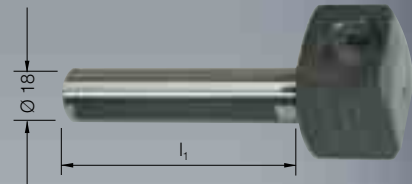

Square turning bits HSS

Designation	s, mm	l_1 , mm	Order No.
VD 6 (4 pieces)	6	40	089 001

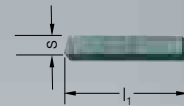

Clamping sleeves

Designation	d_1 , mm	Order No.
SP 308	8	071 103
SP 310	10	071 104
SP 312	12	071 105
SP 314	14	071 106

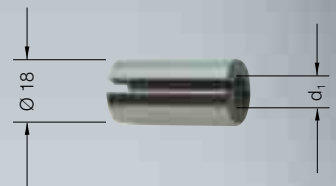

Tool box

Designation	Order No.
Tool box HK 311	099 007



1 Set of accessories

consisting of	Order No.
Boring bars / boring bar holders / square turning bits / clamping sleeves / service key	100 040

Facing and Boring Head UPA 4

The universal tool for facing, boring, recessing, thread cutting and for special work, for use on universal milling machines, jig borers, boring machines etc.

Working range: Ø 0 – 400 mm

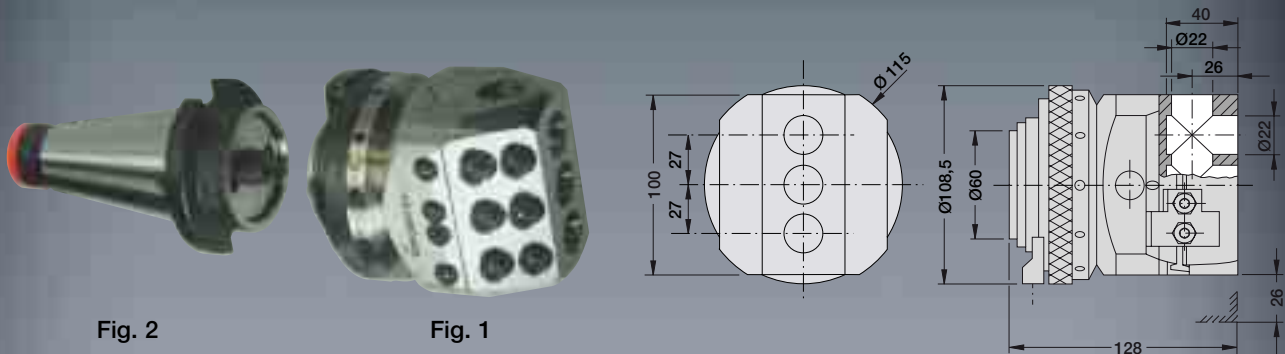

Fig. 2

Fig. 1

	Weight, kg	Order Number
Facing and boring head UPA 4 (as fig. 1)	6.5	007 020

The facing and boring head (fig. 1) is arranged for mounting DS-tool shanks (fig. 2). Because shanks can be exchanged, this facing and boring head can be used on machines with different spindle locations. With each tool shank a differential thread pin and an operation key is supplied. When mounting, the instructions on mounting sheet No. 102 221 should be followed.

DS-tool shanks, fig. 2		Weight, kg	Order Number	No. of drawing
MT 4 x Tang	DIN 1806	0.9	130 005 T00 3590	K 9511
MT 5 x Tang (OERLIKON)	DIN 1806	1.6	130 005 T00 3920	K 9321
ISO 40 x M 16	DIN 69871	1.5	130 005 T01 3815	K 14180
ISO 40 x M 16 cap nut clamps	DIN 2080	1.2	130 005 T00 3703	K 9518
ISO 40 x 5/8 in. – 11 BSW	similar DIN 2080	1.2	130 005 T00 4498	K 9531
ISO 50 x M 24	DIN 2080	2.9	130 005 T00 3704	K 9519
ISO 50 x 1 in. – 8 BSW	similar DIN 2080	2.9	130 005 T00 4480	K 9914
Norm taper 40 x S 20 x 2 with bolts DECKEL		1.2	130 005 T00 5070	K 8622
ISO 40 x M 16	DIN 2080*	1.2	130 005 T01 0229	K 10248
ISO 40 x 5/8 in. – 11 BSW	similar DIN 2080*	1.2	130 005 T01 0327	K 10334
ISO 50 x M 24	DIN 2080*	3.0	130 005 T01 0048	K 10071

* with chucking groove

Other types of shanks on demand

Accessories

Boring bars

Boring depth, mm	Designation	l ₁ , mm	Order No..
45	B 408	80	073 006
85	B 412	120	073 007
125	B 416	160	073 008

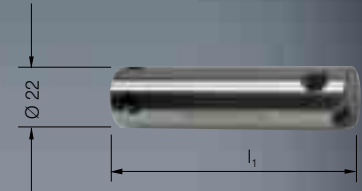

Boring bar holders

Working-Ø, mm	Designation	l ₁ , mm	Order No.
115 – 240	BH 410	98	075 003
220 – 400	BH 418	180	075 004

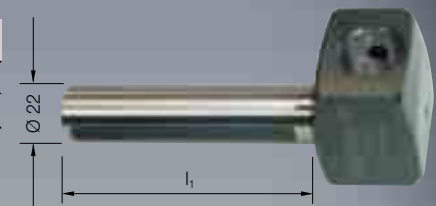

Square turning bits HSS

Designation	s, mm	l ₁ , mm	Order No.
VD 6 (4 pieces)	6	40	089 001

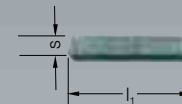

Reinforcement rings and fixing parts

Designation	l ₁ , mm	Order No.
VR 401	10	077 100
VR 402	20	077 101
VR 403	30	077 102
VR 404	40	077 103
Screw		077 104
Disc		077 105



Clamping sleeves

Designation	d ₁ , mm	Order No.
SP 408	8	071 107
SP 410	10	071 108
SP 412	12	071 109
SP 414	14	071 110
SP 418	18	071 111

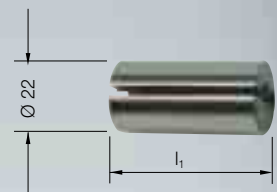

Tool box

Designation	Order No.
Tool box HK 411	099 008



1 Set of accessories

consisting of:	Order No.
Boring bars / boring bar holders /square turning bits / reinforcement rings / clamping sleeves / service key	100 041

Facing and Boring Head UPA 5-S6

The universal tool for facing, boring, recessing, thread cutting and for special work, for use on universal milling machines, jig borers, boring machines etc.

Working range: Ø 0 – 620 mm

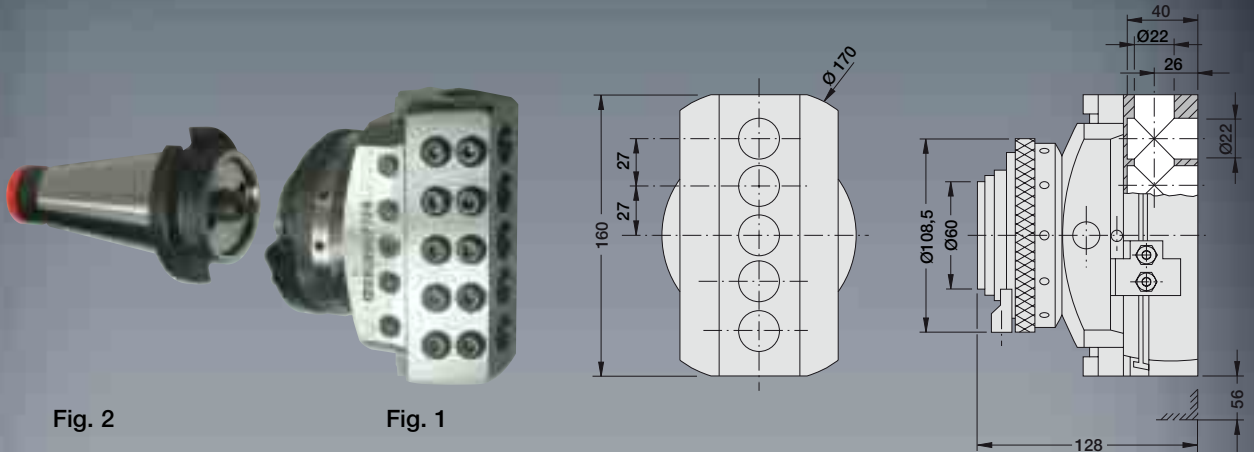

	Weight, kg	Order Number
Facing and boring head UPA 5 (as fig. 1)	7.9	013 020

The facing and boring head (fig. 1) is arranged for mounting DS-tool shanks (fig. 2). Because shanks can be exchanged, this facing and boring head can be used on machines with differing spindle locations. With each tool shank a differential thread pin and an operation key is supplied. When mounting, the instructions on mounting sheet No. 102 201 should be followed.

DS-tool shanks, fig. 2		Weight, kg	Order Number.	No. of drawings
MT 5 x Tang (OERLIKON)	DIN 1806	1.6	130 005 T00 3920	K 9321
ISO 40 x M 16	DIN 69871	1.5	130 005 T01 3815	K 14180
ISO 40 x M 16 cap nut clamps	DIN 2080	1.2	130 005 T00 3703	K 9518
ISO 40 x 5/8 in. – 11 BSW	similar DIN 2080	1.2	130 005 T00 4498	K 9531
ISO 50 x M 24	DIN 2080	2.9	130 005 T00 3704	K 9519
ISO 50 x 1 in. – 8 BSW	similar DIN 2080	2.9	130 005 T00 4480	K 9914
Norm taper 40 x S 20 x 2 with bolts DECKEL		1.2	130 005 T00 5070	K 8622
ISO 40 x M 16	DIN 2080*	1.2	130 005 T01 0229	K 10248
ISO 40 x 5/8 in. – 11 BSW	similar DIN 2080*	1.2	130 005 T01 0327	K 10334
ISO 50 x M 24	DIN 2080*	3.0	130 005 T01 0048	K 10071

* with chucking groove

Other types of shanks on demand

Accessories

Boring bars

Boring depth, mm	Designation	l_1 , mm	Order No.
45	B 408	80	073 006
85	B 412	120	073 007
125	B 416	160	073 008

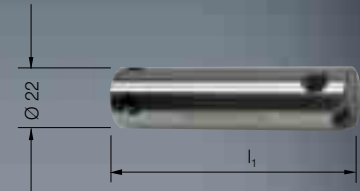

Boring bar holders

Working-Ø, mm	Designation	l_1 , mm	Order No..
120 – 400	BH 513	128	075 005
270 – 620	BH 523	230	075 006
for extended assembly	BH 410 (2 pieces)	98	075 003

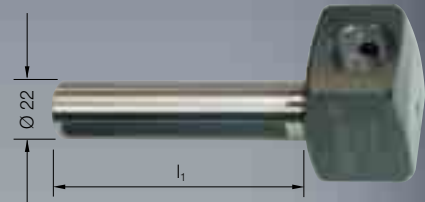

Square turning bits HSS

Designation	s, mm	l_1 , mm	Order No.
VD 6 (4 pieces)	6	40	089 001

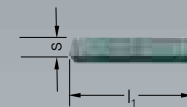

Reinforcement rings and fixing parts

Designation	l_1 , mm	Order No.
VR 401	10	077 100
VR 402	20	077 101
VR 404	40	077 103
VR 407	70	077 108
Disc		077 105
Screw		077 109
Screw		077 110



Clamping sleeves

Designation	d_1 , mm	Order No.
SP 408	8	071 107
SP 410	10	071 108
SP 412	12	071 109
SP 414	14	071 110
SP 418	18	071 111

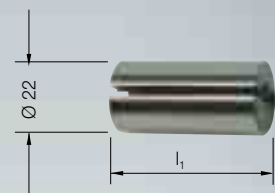

Tool box

Designation	Order No.
Tool box HK 511	099 009





1 Set of accessories

consisting of:	Order No.
Boring bars / boring bar holders /square turning bits / reinforcement rings / clamping sleeves / service key	100 044

Clamping holder for replaceable inserts

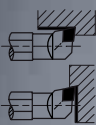
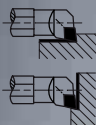
The clamping holders with round shank are for facing and boring and are fixed directly in the slide of the facing and boring heads or in the boring bar holders

Form and application	Boring range Ø min.	Suitable for facing and boring head	Measurements			Order No.
			d ₁	l ₁	r ₁	
 Right hand clamping holder 95° : - for boring - for facing from inside to outside	27	UPA 3	18	80	13.5	081 087
	27	UPA 4 and UPA 5-S6	22	100	13.5	081 092
 Left hand clamping holder 95° : - for hub boring - for facing from outside to inside	27	UPA 3	18	80	13.5	218 088
	27	UPA 4 and UPA 5-S6	22	100	13.5	218 089
 Right hand clamping holder 80°: - for boring	27	UPA 3	18	80	13.5	081 088
	27	UPA 4 and UPA 5-S6	22	100	13.5	081 093
 Right hand clamping holder 80°: - for facing from inside to outside	27	UPA 3	18	80	7.5	081 089
	31	UPA 4 and UPA 5-S6	22	100	7.5	081 094

Replaceable inserts

Replaceable insert form 103 you find in our catalog
MultiBore System tools 90100.

Cutting tools

		Order No.
Blank of cutting tool VD 6/0 for UPA 3, UPA 4 and UPA 5-S6	HSS	089 100
	Hard metal ¹⁾	091 100

¹⁾ When ordering please indicate apart from the ordering code also the HM quality, e.g. K 10, P 20, M 10.

UPA 3



UPA 4



UPA 5-S 6



Wohlhaupter range

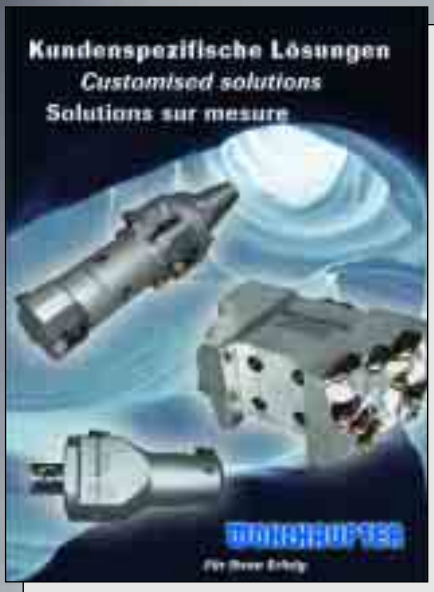
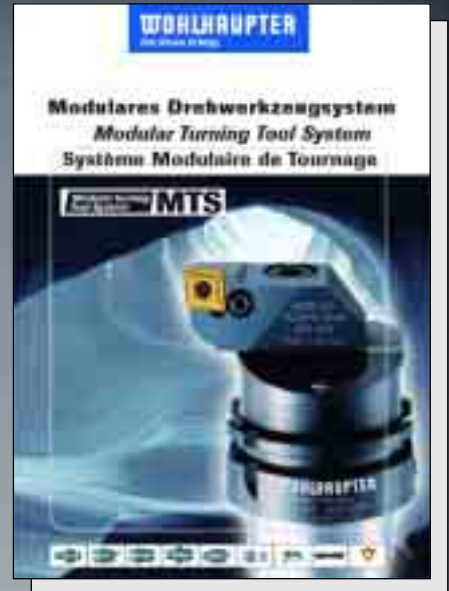
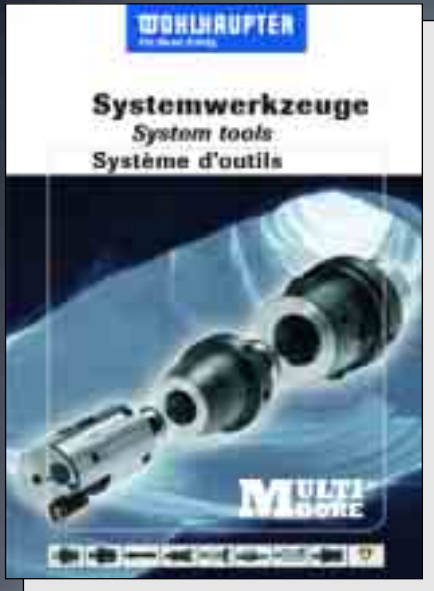

WOHLHAUPTER

Für Ihren Erfolg.

Wohlhaupter GmbH Präzisionswerkzeuge
 Maybachstraße 4 • 72636 Frickenhausen
 P.O. Box 1264 • D-72633 Frickenhausen
 Phone (0 70 22) 408-0 • Fax (0 70 22) 408-212
 Internet: www.wohlhaupter.de
 E-Mail: info@wohlhaupter.de

Certificated Quality Management goes
 without saying with Wohlhaupter.

